

skillevægge

skydedøre

glasvægge

døre

rumdeling

## PROFILOVERSIGT - CUBE VÆGSSYSTEM

Vandret snit

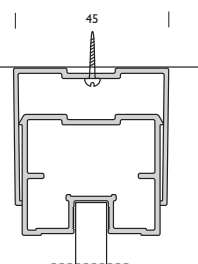

Startprofil mod væg

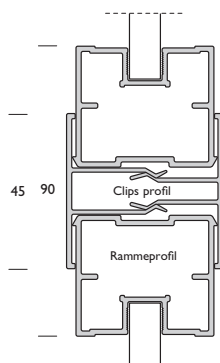

Clips profil

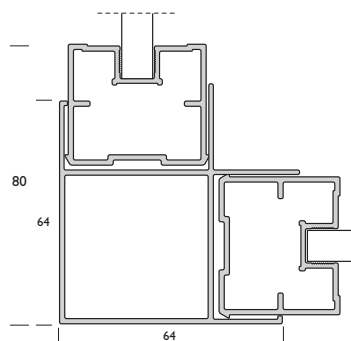

90° hjørneprofil

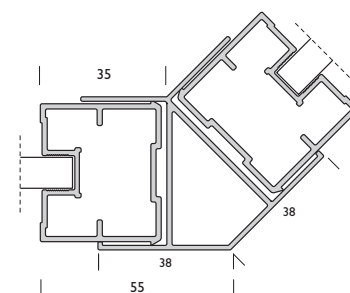

45° hjørneprofil

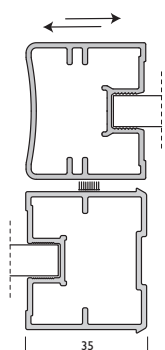

Skydedør med børstetætning (option)

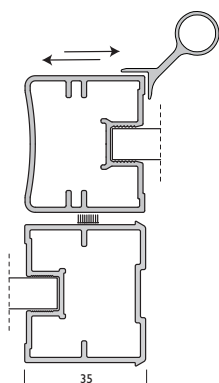

Skydedør med udvendigt greb (option)

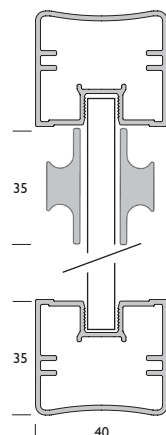

Skydedør med indvendigt greb, påklæbet (option)

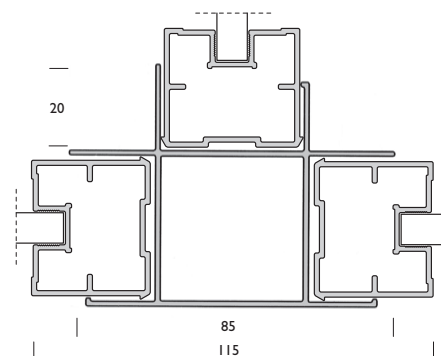

T-løsning

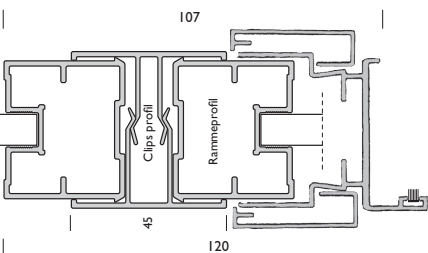

Dørramme med karm mellem 2 faste vægmoduler

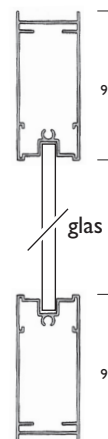
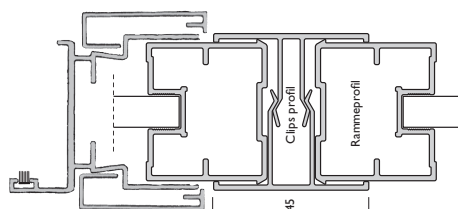

Sideprofil på CUBE dør

skillevægge

skydedøre

glasvægge

døre

rumdeling

## PROFILOVERSIGT - CUBE VÆGSSYSTEM

Lodret snit

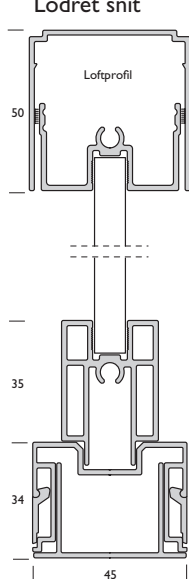

Fast væg med justerbar sokkel

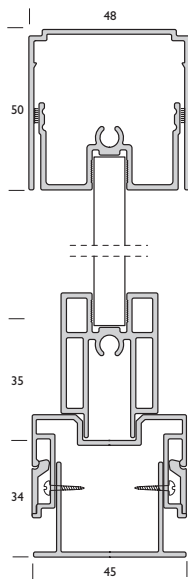

Eksempel på fast væg med justerbar sokkel

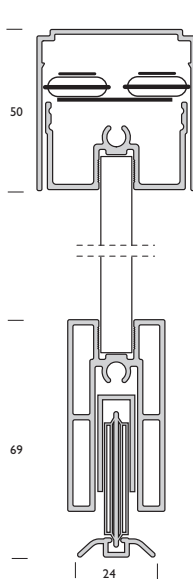

Skydedør med tophjul og justerbar bundhjul

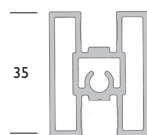

Sprosse til vandret deling af væg/dør



Sprosse til påklæbning

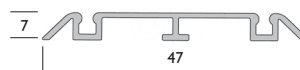

Dobbelt køreskinne



Enkelt køreskinne



Enkelt køreskinne til nedfræsning

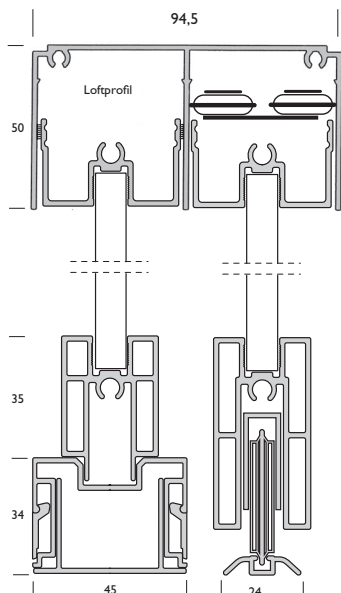

Dobbelt loftprofil

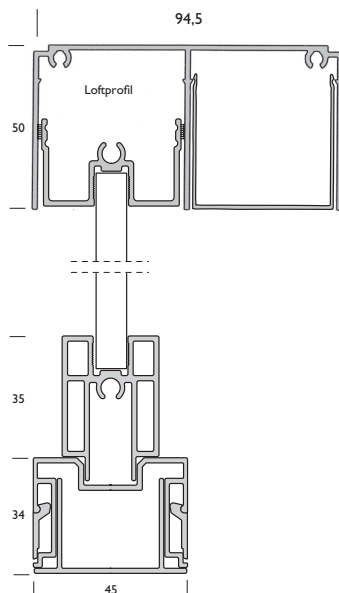

Dobbelt loftprofil med dæk profil

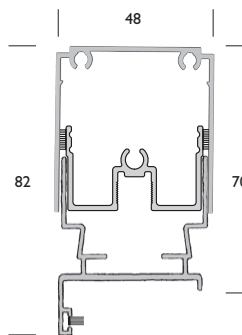

Overramme CUBE dør

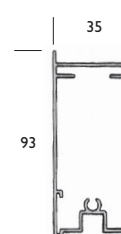

Topprofil CUBE dør

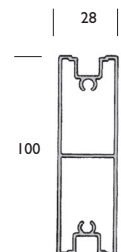

Bundprofil CUBE dør